



SPE/IADC SPE-166773-MS

The Importance of Acceptable Electrical Power Quality to the Drilling Industry Worldwide

Ian C Evans, Harmonic Solutions (Oil & Gas), Ras Al Khaimah, United Arab Emirates

Copyright 2013, SPE/IADC Middle East Drilling Technology Conference and Exhibition

This paper was prepared for presentation at the SPE/IADC Middle East Drilling Technology Conference and Exhibition held in Dubai, UAE, 7–9 October 2013.

This paper was selected for presentation by an SPE/IADC program committee following review of information contained in an abstract submitted by the author(s). Contents of the paper have not been reviewed by the Society of Petroleum Engineers or the International Association of Drilling Contractors and are subject to correction by the author(s). The material does not necessarily reflect any position of the Society of Petroleum Engineers or the International Association of Drilling Contractors, its officers, or members. Electronic reproduction, distribution, or storage of any part of this paper without the written consent of the Society of Petroleum Engineers or the International Association of Drilling Contractors is prohibited. Permission to reproduce in print is restricted to an abstract of not more than 300 words; illustrations may not be copied. The abstract must contain conspicuous acknowledgment of SPE/IADC copyright.

Abstract

Electrical power quality is routinely taken for granted by oil and drilling industries worldwide despite the fact that the quality of electrical power is fundamental to the safety and operational integrity of drilling rigs and oil production platforms worldwide, without exception. US\$100m's are lost each year, direct and indirectly, due to poor quality of power.

Currently some offshore safety authorities are considering the imposition of strict limits on harmonic voltage distortion in their jurisdiction. Harmonic voltage distortion may become a regulatory issue in the future.

This paper examines the salient harmonic and power quality issues onboard drilling rigs with full SCR drilling packages, as well as the more recent hybrid (mixed SCR and VFD drives) and full VFD (variable frequency drive) drilling packages.

With SCR drives the main problems are harmonic voltage distortion, line notching and voltage spikes which destroys capacitors inside equipment. Low generator power factor is also often an operational problem.

For VFDs, harmonic voltage distortion is also a problem but increasingly so is excessive common mode voltage caused by VFD operation which disrupts susceptible electronic equipment.

The paper will offer advice on proven solutions for common power quality problems and introduce a remote/local power quality monitoring system which can be easily retrofitted to existing rigs and platforms.

1.0. Introduction

The quality of electric power (i.e. voltage supplies) is absolutely crucial to the operational integrity and safety of any land-rig, offshore drilling rig/ship or offshore installation, irrespective of type or class. Any failure or malfunction of equipment due to poor power quality can result in expensive downtime or, in a worst case scenario, severe or disastrous consequences.

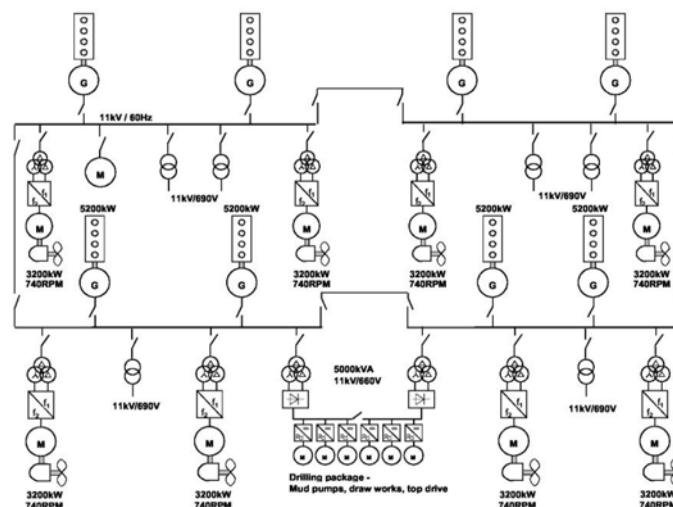

Fig 1 : DP3 drilling rig with 25.6MW of thrusters and 5000kVA of drilling package drives, all VFDs

Electric drives, both DC drives (i.e. “SCR drives”) and AC variable frequency drives (VFDs), are commonplace on drilling rigs and offshore installations (Fig 1). Their operation significantly reduces the quality of electric power, increases equipment failure with resultant down-time and can lead to safety being compromised.

Power quality is taken for granted in the drilling and oil industries. Rarely is the electricity supply quality monitored and, even after a serious incident or disaster, it is never investigated or considered to be a contributory factor. To date only a very limited number of ‘Blackbox’ recorders, which automatically capture and store power quality data and provide early warning of power quality problems, are installed. There have been rules and recommendations for the limitation of harmonic voltage distortion in place for some years but are often ignored. Voltage distortion offshore (and or land-rigs) can, in the experience of the author, exceed the recommended limits by a factor of up to four to six times.

US\$100m’s are lost annually across the industry, direct and indirectly, due to poor power quality. The industry is often unaware of the cause of the disruptions or where the damage to equipment originates from. Little or no training is provided for rig electricians and little or no harmonic and power quality measurements taken.

Some consequences of poor power quality can appear relatively minor (e.g. the repeated burning out of a system control relay, contactor coil or electric motor). However, these failures are often expensive operationally due to the resultant downtime. There is also potential for something considerably more serious. For example, in July 1988, the world’s worst oilfield disaster, (as far as human life was concerned), occurred off Scotland on the Occidental platform, Piper Alpha. 167 men perished. The Cullen Enquiry, set up to investigate the disaster, failed to establish the source of ignition which ignited the escaping condensate.



Fig 2 : Piper Alpha platform off Scotland which exploded and caught fire in July 1988 killing 167 men

Some 30 years on, a growing number of electrical engineers within the industry accept that it is not outwith the realms of possibility that a combination of excessive harmonic voltage distortion, ExN (non sparking) compressor motors with double cage rotors (i.e. which can attain high temperatures in the presence of harmonics) and the escape of condensate could be the combination which resulted in the conflagration and tragic loss of life on Piper Alpha. The effects of harmonic voltage distortion was never considered by the Cullen Enquiry. At that time there was only rudimentary harmonic measurement equipment available and problems of harmonics were largely unknown to the industry.

A few years ago the author had an exploratory meeting with the UK’s Health & Safety Executive (Offshore Division) to discuss offshore power quality issues. The discussion touched on the serious fire which occurred in March 2006 on the Shell Tern platform in the North Sea, where according to the newspapers, “an electric motor caught fire”. The platform was evacuated and the blaze subsequently took eight hours to extinguish. HSE stated that the cause of the fire was not an electric motor but refused to state what their investigation had uncovered. The author asked if the harmonic voltage distortion had been measured before and/or after the incident. “No, why ?” said the HSE Senior Inspector, to which the author retorted, “how do you know harmonics was not a contributory factor then ?” The message here was as clear then as it is now; if you do not measure your power quality, then you are in the dark and not in control of events.

Should any serious incident or disaster occur, then the owners and operators will be exposed to investigation by the authorities. The question is “will they be prosecuted should poor power quality be proven to be a contributory factor ?”

2.0. Existing harmonic voltage distortion limits

Whilst offshore production platforms and land-rigs use national or international standards and recommendations including IEC 6000-2-2, IEC 6000-2-4, API RP 14F and IEEE 519-1992 for guidance on limiting harmonic voltage distortion, the limits for offshore drilling rigs are within the rules of marine classification societies including the American Bureau of Shipping (ABS), Det Norske Veritas (DNV) and Lloyds Register of Shipping (LR).

The majority of classification societies set limits on total harmonic voltage distortion (U_{thd}) at 5% together with a limit of any single harmonic <3%.

Lloyds Register of Shipping have a total harmonic distortion limit of 8% with a limit on any single harmonic voltage above the 25th harmonic of <1.5%.

The American Bureau of Shipping introduced the MODU (Modular Offshore Drilling Units) rules in 2008 which included a limit on the total harmonic voltage distortion (U_{thd}) of 8% with a limit of any single voltage harmonic of <5%. Det Norske Veritas (DNV) introduced similar limits in 2011.

Note that limits on harmonic current distortion do not apply for marine vessels, drilling rigs or offshore generator derived voltage supplies.

Some classification societies, including ABS, can offer the option of higher permissible levels of U_{thd} (up to 10% or 20%) on the proviso that all the connected equipment is specifically designed for the specified higher U_{thd} levels, something which can be both impractical and expensive. Most electrical equipment can tolerate up to 5% U_{thd} without adverse effects in terms of reliability and operational functionality. Above 5% U_{thd} however, there are problems associated with most types of equipment.

Marine classification society 'rules' however are only recommendations which the client may choose to ignore for financial or other reasons. The ultimate sanction for not complying with the rules is removal from class. This rarely is enforced due to commercial considerations.

Rules on harmonic voltage distortion are not retrospective and are designed primarily for new builds. Their implementation however is strongly recommended for existing rigs which may have developed operational problems due to poor power quality.

Whilst harmonics are covered by marine classification society's rules they are, in the experience of the author, often inadequately enforced and policed by those same bodies. There have been numerous instances of rigs leaving shipyards with high levels of harmonic voltage distortion, well above the prescribed limits, yet having obtained the appropriate 'approval'. The 'measurement' of harmonic distortion often is confined to a computer screen with little or no actual compliance testing, contrary to the rules of at least one major classification body. This short-sighted approach can be expensive to the owners and operators in future years.

In the experience of the author it is not uncommon to see drilling rigs without any harmonic mitigation, achieving U_{thd} levels of between 25-35%. Consequently, a number of offshore safety authorities are increasingly concerned regarding the effects of harmonics and are currently considering the imposition of strict U_{thd} limits for all installations in their jurisdiction. U_{thd} limits in the future may be policed by safety authorities, possibly utilising remote power quality monitoring devices similar to that introduced in this paper.

3.0. Harmonics is not the only problem

Power quality is not solely about harmonic voltage distortion. Other serious power quality problems exist on drilling rigs including :

- a) Line notching due to large DC SCR drives.
- b) Voltage spikes due the interaction of line notching with cable and other stray capacitances.
- c) Excessive common mode voltage due to the operation of VFDs. (This has consequences for motor bearing failures and disruption of equipment).

None of the marine classification societies have rules for the above phenomena and most rules are totally inadequate for today's drilling rig and offshore electrical environment.

In May 2006 ABS published a 240 page document entitled, "*Guidance Notes for the Control of Harmonics in Electrical Power Systems*" (Publication 150). The majority of marine classification societies refer their clients to this publication which has excellent guidance on harmonics and associated topics. The document was recently updated with additional chapters on voltage spikes, common mode voltage and other important topics. To date ABS have not released the revised publication which when available it will be invaluable to their clients and the industry in general.

4.0. Cause for concern : explosion-proof motors

Harmonic voltages and currents affect generators, transformers and induction motors which require thermal derating in their presence. There is however a further 'complication' regarding fixed speed explosion-proof motors based on IEC and UL/NEMA standards. These motors are only certified for use on sinusoidal supplies (0% U_{thd}). For example, the IEC standard relating to electrical machines, IEC60034-1, specifies the requirements regarding 2-3% 'harmonic voltage factor' (HVF) due to the effects of harmonics on winding temperature. IEC 60079-1 (hazardous area equipment) however does not currently have any requirement for HVF regarding compliance testing or certification for any explosion-proof motor protection concepts (i.e. different type of explosion-proof motors). It is a similar situation for NEMA/UL motors under standard MG-1.

If these motors are subject to voltage supplies with $>0\%$ Uthd they are uncertified as they are “operating outwith the conditions envisaged when they were certified”. This does not mean the motors are unsafe (although under certain conditions they could be) but that the operator has lost any third party (e.g. NEMA/UL/ PTB, CSA, BASEEFA et al) verification as to their safety under all operating conditions.

There is a second serious and practical consideration regarding flameproof induction motors and harmonic voltage distortion. The flameproof motor (i.e. EExd in IEC codification) relies on the principle that no matter what happens inside the flameproof enclosure (e.g. an internal explosion) it cannot transmit to the surrounding hazardous area. While that statement may be perfectly valid for sinusoidal voltage supplies it is not valid for voltages supplies polluted with harmonics.

A flameproof motor relies solely on the flameproof enclosure and flame paths in the end housings to contain any internal explosion in the event of gas or vapour entering the machine. However, in the presence of harmonics, most notably on motors with deep bar or double cage rotors, the rotor temperature rise can be excessive and possibly well outside the motor temperature class (e.g. 200 deg C for an EExd IIB T3 motor). High rotor temperatures can affect the bearings as the lubrication degrades, exposing them to excessive wear. This can degrade the flame paths and if there is an internal explosion, perhaps more likely due to high rotor temperatures, then it may not be contained and transmission to external hazardous areas may result with potentially disastrous consequences.

In order to overcome this deficiency the standards authorities place the sole responsibility on operators to maintain their harmonic voltage distortion at a safe and acceptable level (i.e. 5-8% Uthd) such that explosion-proof motor safety is not compromised. The author is unsure how the same authorities would react to the reality of explosion-proof motors being regularly subjected to 25%-35% harmonic voltage distortion levels as witnessed during his numerous offshore harmonic measurements.

5.0. Harmonic voltage distortion

The negative effects of harmonics are acknowledged in many technical papers and do not require any explanation here other than to state that they generally fall into two basic categories :

- Excessive heating caused by additional I^2R losses, iron losses, skin effect, etc in cables and equipment (e.g. generators, transformers and motors).
- Voltage distortion resulting from harmonic currents, at the various frequencies, passing through the system impedances and leakage inductances of the power system, disrupting or destroying susceptible equipment.

Harmonic voltage distortion is essentially ‘pollution’ of the supply voltage and is ‘seen’ by all equipment connected to the power system.

Most conventional variable AC and DC speed drives offshore are ‘6 pulse’ (i.e. one three phase rectifier). When fed with sinusoidal voltages, they draw non-sinusoidal or ‘non-linear current’ from the supply (Fig 3) and are hence termed ‘non linear loads’.

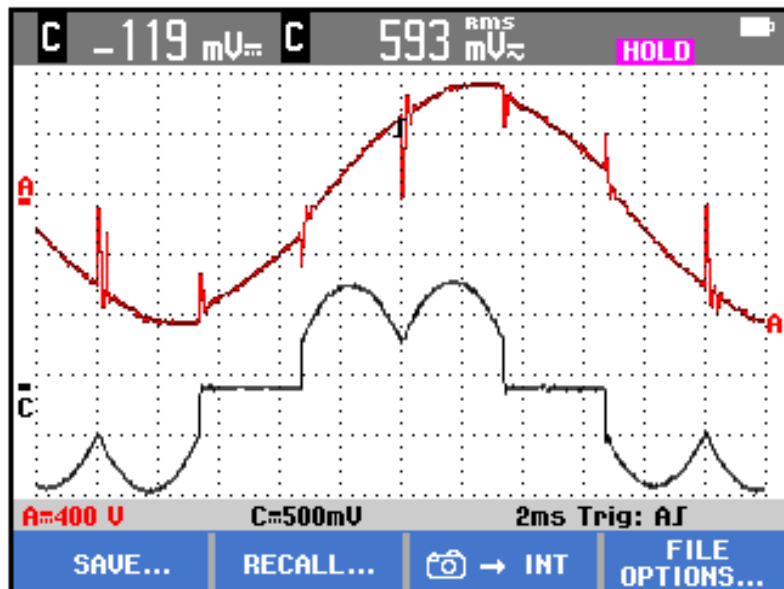

Fig 3 : Typical non linear load. 6 pulse SCR drive (upper trace is line voltage, lower trace is current)

During the conversion process from AC to DC, SCR drives and VFDs draw unwanted harmonic currents, (i.e. multiples of the supply frequency) from the source [e.g. the 5th harmonic current is 5 x 60Hz = 300Hz]. The three phase ‘characteristic’ harmonics currents are dependent on the number of three phase (i.e. 6 pulse) input rectifiers in the non linear load(s) and is based on the equation :

$$I_h = n.p \ +/-1 \dots\dots\dots(1)$$

Where n is an integer, p is pulse number (e.g. ‘6’ for 6 pulse)

Examples of characteristic harmonic orders :

- 6 pulse = 5, 7, 11, 13, 17, 19, 23, 25..... (example in Fig 4)
- 12 pulse = 11, 13, 23, 25, 35, 37.....
- 18 pulse = 17, 19, 35, 37.....
- 24 pulse = 23, 25, 47, 49.....
- 36 pulse = 35, 37.....

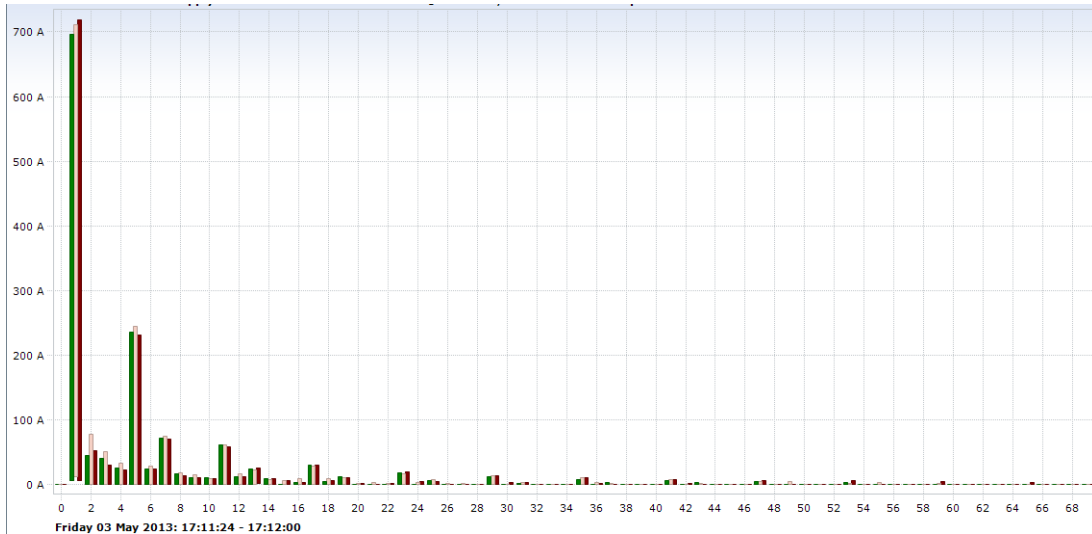

Fig 4 : Characteristic harmonic currents - 6 pulse SCR drive

The individual harmonic currents interact with the system impedances at their respective harmonic frequencies to produce voltage distortion at those frequencies.

This is based on Ohms Law :

$$U_h = I_h \times Z_h \dots\dots\dots(2)$$

U_h is the harmonic voltage at a specific frequency
I_h is the harmonic current at a specific frequency
Z_h is the impedance at a specific frequency

The individual harmonic voltages *U_h* are summed as follows. The result is termed the “total harmonic voltage distortion” (U_{thd}) :

$$U_{thd} = \frac{\sqrt{\sum_{h=2}^{\infty} U_h^2}}{U_1} \times 100\%$$

$$= \frac{\sqrt{U_5^2 + U_7^2 + U_{11}^2 + \dots + U_n^2}}{U_1} \times 100\% \dots\dots\dots(3)$$

Where *U₅, U₇, U₁₁* etc harmonic voltages 5/7/11...
U₁ is the fundamental voltage
U_{thd} is the total harmonic voltage distortion

Note that ‘U_{thd}’ (or THDu) relates to line voltage distortion whereas ‘V_{thd}’ (or THDv) relates to phase voltages distortion. ‘I_{thd}’ (THDi) relates to phase current distortion.

It can be appreciated from above formula (2) that the higher the non linear loading in kW, the higher the magnitude of the harmonic currents and the higher the subsequent voltage distortion (U_{thd}).

It can be stated therefore that if no non linear loads are present the rms current and rms line voltages will be sinusoidal and U_{thd} will be relatively low. A practical example can of this is illustrated in Fig 5.

5.1. Practical example of harmonic voltage distortion

Fig 5 illustrates generator measurements on a land-rig. No drilling was in progress; only the hotel loads and ancillaries were running. The line voltage and current waveforms were sinusoidal. From the bottom trend, the Uthd is observed to be relatively low (0.25-0.47%).

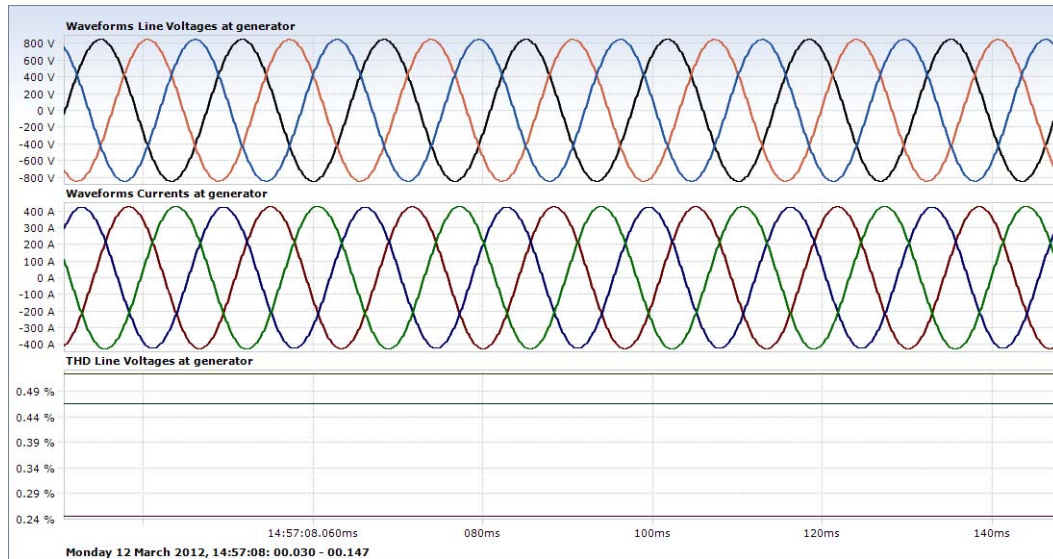

Fig 5 : Landrig generator without any drilling load (i.e. drilling package not operating). Uthd 0.25-0.47%

Figs 6 to 8 (inclusive) illustrate the effects on the generator power quality of the operation of the SCR drilling package. The Uthd can be seen at 19.3%. The maximum Uthd recorded during the visit was 26.23%. The VFD top drive was supplied via its own generator so did not contribute directly to the Uthd, which otherwise would have been much higher (~29-31% Uthd).

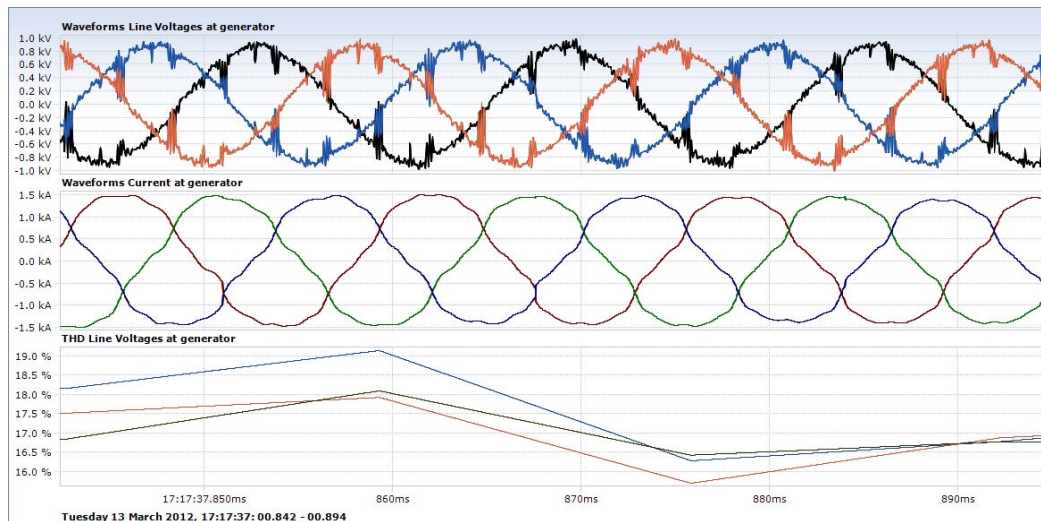

Fig 6 : Generator power quality on SCR drilling package. 19.3% can be observed (U3) – bottom trend.

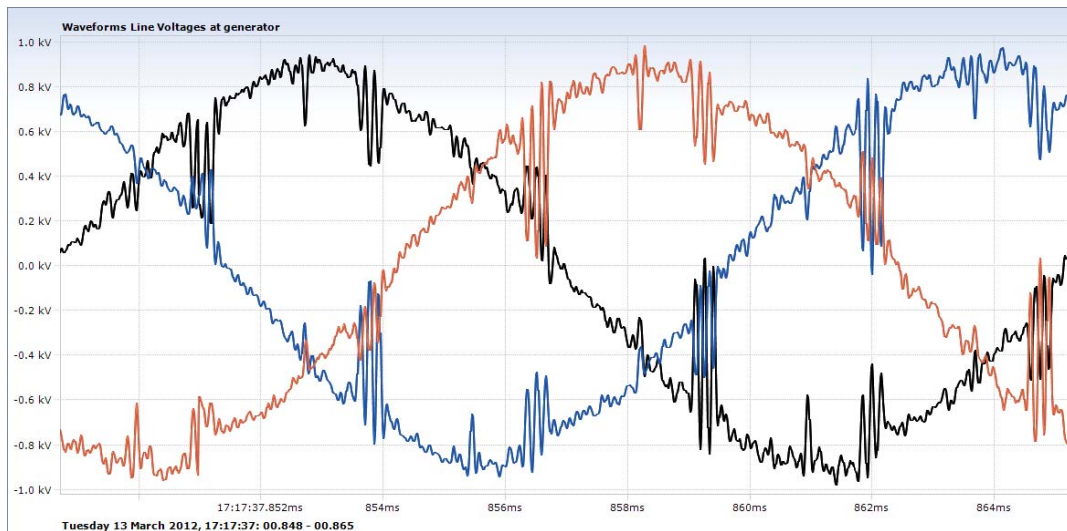

Fig 7 : Detailed view of the voltage waveform distortion, including line notching at the generator terminals

The multiple line notching observed (Fig 7) was due to the operation of three SCR drives (i.e. two mud pumps and the draw-works), each with a different control angle.

The high frequency ripple seen on the waveforms was partially due to the common mode voltage of the separately supplied top drive VFD. Incorrect EMC installation and incorrect grounding of the top drive VFD resulted in the common mode voltage (comprising the VFD IGBT bridge switching frequency) being superimposed on the phase to ground voltage. This impacted on drilling switchboard 200 metres away. There was no electrical connection between the main switchboard and the top drive other than the ground connection.

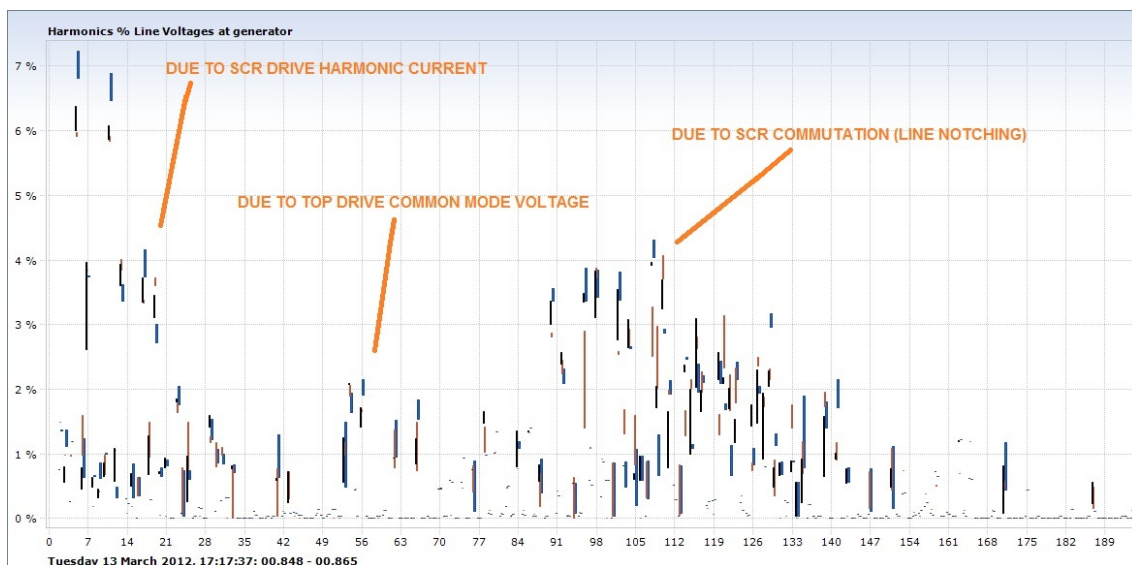

Fig 8 : Min/max line voltage harmonic spectrum during the period of measurement seen in Fig 5

The min/max harmonic line voltage spectrum shown in Fig 8 had three separate sub-spectrums. Harmonic orders up to the 42nd were due to the harmonic currents drawn by the SCR drives. The orders around the 50-64th harmonic was the reflection of the common mode voltage, travelling from the top drive via the ground to the switchboard (i.e. VFD switching frequency was 3.3kHz {~56th harmonic}). The higher frequency voltage harmonics (85-150th) were due to the SCR line notching.

Higher frequency measurements are rarely captured as most power analysers only measure to the 50th harmonic. Most classification society's rules also limit measurements to the 50th order; indicating a serious deficiency in the rules.

5.0.1. Mitigation options for harmonic voltage distortion

- a) Series connected Lineator wide spectrum passive filters offer an excellent level of mitigation for VFDs and SCR drives and isolate drives from mains disturbances.

- c) Parallel passive tuned filters, occasionally used, have serious issues with excessive reactive power injected into the generators at light or no load conditions. Loss of harmonic tuning due to aging and the subsequent effect on resonance and performance are further considerations.
- d) Active filters are complex but offer excellent mitigation performance. However they do require at least 3% AC line reactance installed in each VFDs and SCR drives for successful application.
- e) Multi-pulse drives (e.g. 12 or 18 pulse) or quasi multi-pulse rectifier systems (e.g. 24 pulse feeding a common DC bus system for VFDs). Difficult to retrofit.

Note that no form of harmonic mitigation is perfect. A thorough understanding of all the mitigation options and their impact on the specific power system is crucial to ensuring optimum selection of mitigation type. Cost, performance, ease of installation and maintainability are all factors requiring careful consideration.

6.0 Line notching

Line notching is a phenomenon associated with the 'phase controlled' rectifiers, including SCR drives in drilling industry. The effects of 'line notching' can have a serious impact on the supply system and other equipment.

Fig 9 depicts a simple three phase full wave, 6 pulse SCR bridge supplying a DC motor load.

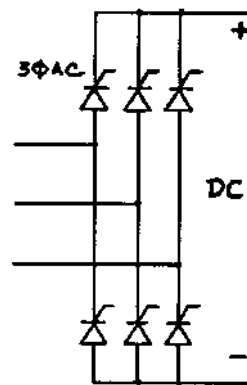

Fig 9 : Simple three phase thyristor bridge for phase control as used for SCR drives

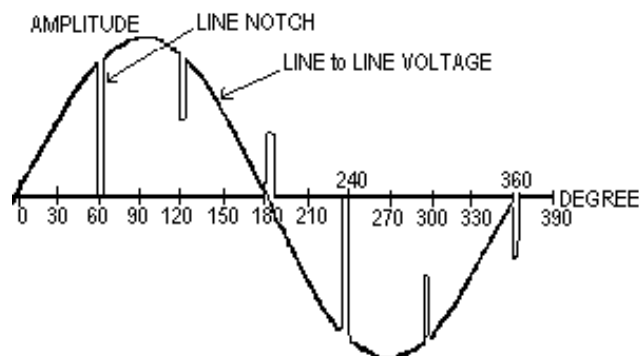

Fig 10 : Idealised example of 'line notching' if no reactance in circuit in each SCR drive

Fig 10 illustrates theoretical notching at the terminals of the SCR bridge and assumes no additional inductance (reactance) in circuit. The voltage notches occur when the continuous line current commutates (i.e. transfers) from one phase to another (every 60 degrees). During the commutation period two phases are short circuited for very short durations of time through the converter bridge and the AC source impedance. The result is that the voltage reduces to almost zero as the current increases, limited only by the circuit impedance (as seen in Fig 10) which is negligible.

The disturbances associated with line notching tend to progressively reduce the nearer to a 'stiff' source impedance (i.e. an impedance of relatively low value with relatively high short circuit capacity). Generators however are 'soft sources' (i.e. high impedance) and can be adversely affected by line notching and require special filters on the AVRs (automatic voltage regulators) to maintain a stable feedback voltage.

Where there are no additional AC line reactance in SCR drives, the norm in the drilling industry, the voltage can be reduced to zero, creating additional 'zero crossovers' (i.e. the points where the voltage would normally change polarity). These spurious zero crossovers can affect generator AVRs, SCR bridge firing circuits and other equipment which depend on true zero crossovers for timing or control.

Using the land-rig example, we can clearly see in Fig 11, the multiple line notching due the three SCR drives operating.

Under conditions of low speed (low DC voltage) and high torque demand (high DC current) the line notching would extend to zero since no AC line reactors (i.e. inductances) were installed in the SCR drives. The only impedances between the SCR drive(s) and the generator were the generator cables and switchboard busbars.

Note that the lack of AC line reactors in SCR drives throughout the industry impacts significantly on power quality. It is poor engineering practice repeated since the 1960s.

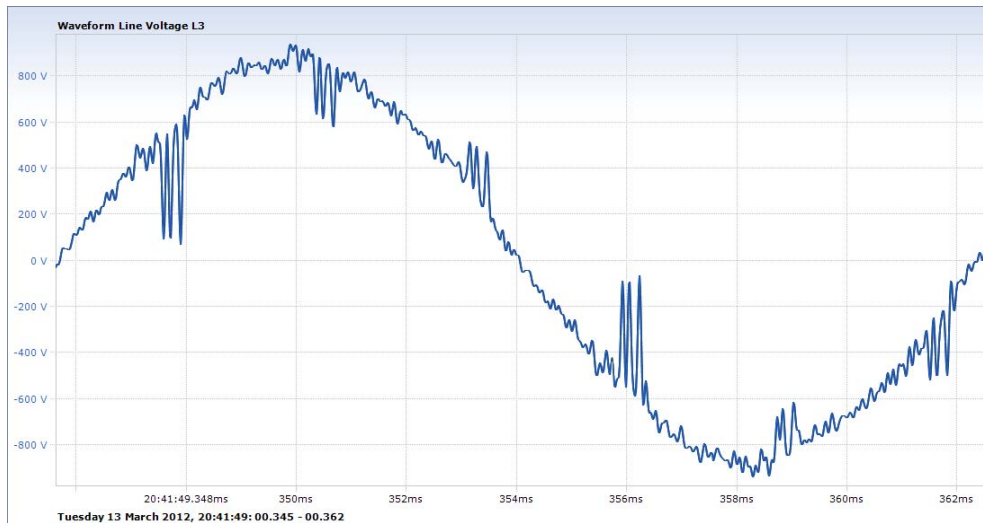

Fig 11 : Triple line notches can be seen due to three SCR drives operating at different control angles. See also Fig 12

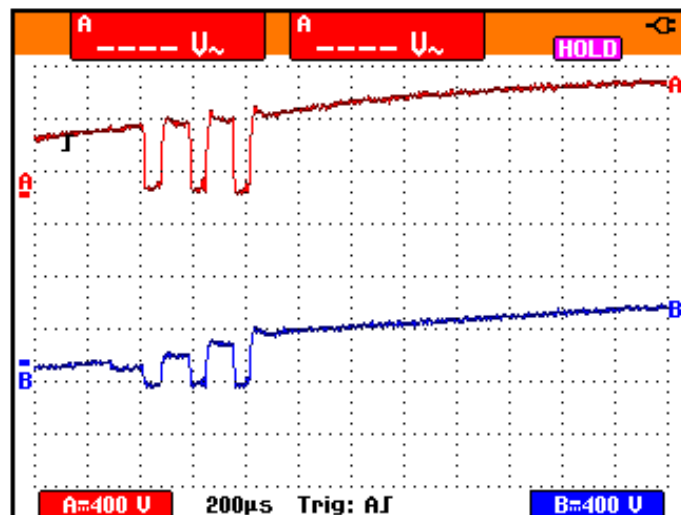

Fig 12 : 200MHz scopemeter screenshot show line (red) and phase (blue) voltages. The three line notches can easily be seen.

6.0.1. Mitigation of line notching

- ◆ For SCR drives install at least a 3% AC line reactor in each drive. This will raise the voltage notch above the zero line and prevent spurious zero crossovers but will widen the notch; the notch energy can only be reduced by injecting reactive energy into it.
- ◆ Both Lineator wide spectrum filters and high performance active filters, the latter in combination with at least 3% AC line reactors, can offer harmonic mitigation and a more than reasonable degree of attenuation of voltage line notches.

7.0. Voltage spikes

Often associated with line notching is the serious phenomenon termed “ringing” (i.e. high frequency oscillations due to the rapid switching of SCRs devices), as illustrated in Fig 13. It is the result of high frequency ‘resonance’ in the rectifier circuit due to inherent inductance and capacitance in the equipment circuitry. The lack of AC line reactors in SCR drives increases the possibility of ringing.

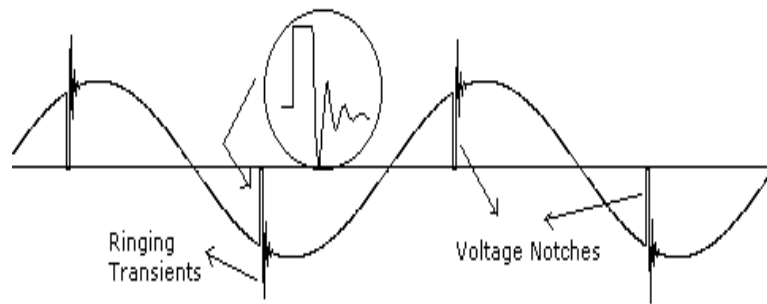

Fig 13 : SCR line notching and associated 'ringing'

Note that line notching and ringing do not usually influence the 'official' U_{thd} as the harmonic voltages associated with them are at higher frequencies (i.e. above the maximum harmonic order considered by most rules (i.e. 50th) and measured by most power analysers).

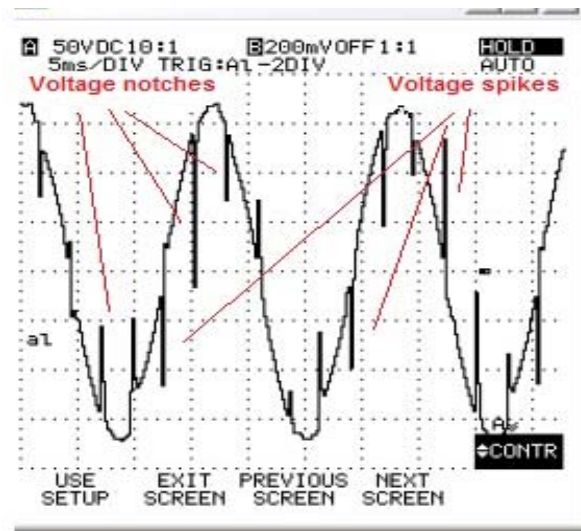

Fig 14 : Example of repetitive voltage spikes

Repetitive voltage spikes (Fig 14) are the result of interaction between SCR drive line notching and cable and other stray capacitances. Voltage spikes destroy capacitors in various types of equipment including VFDs (Fig 16), fluorescent lighting, switched mode power supplies. They also damage motor windings. VFDs can trip on 'overvoltage, DC bus' due to voltage spikes.

The oscilloscope screenshot in Fig 15 illustrates ringing in a an SCR drive voltage waveform with two primary voltage notches.

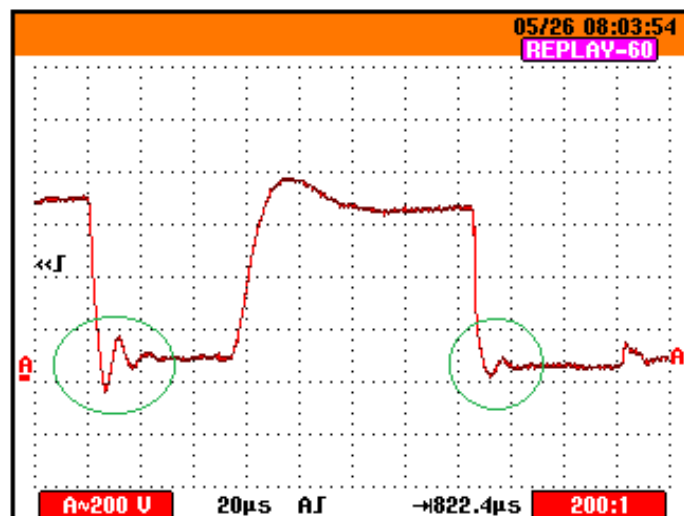

Fig 15 : Ringing in two primary line notches of an SCR drive

The high frequency energy within each discrete notch has the potential to induce voltage ringing (Fig 15). The notch has a relatively high frequency compared to the fundamental frequency (e.g. 60Hz) and can be excited by the power system resonance. If the system impedance happens to create a resonance point close to the notch frequency, then ringing can result in repetitive voltage spikes (Fig 14), the effects of which can be seen (Fig 16).

Note that the dv/dt (i.e. rate of rise of voltage) of the voltage spikes can also accelerate failures, if excessive.



Fig 16 : Result of repetitive voltage spikes. Diode packs destroyed and DC bus capacitors destroyed in shaker VFDs.

On one jack-up rig the following failures, recorded over a three month period, were attributed to repetitive voltage spikes :

- Four VFD EMC filters destroyed
- Multiple failures (>10 off) 24V switched mode power supplies
- Multiple failures (>12 off) thermostats
- Numerous failures of fire & gas detection system input filters
- Repeated and multiple failure of fluorescent lighting capacitors

7.0.1. Mitigation of voltage spikes

- ◆ The most common cause of voltage spikes is SCR drives without AC line reactors. At least 3% AC line reactors should be installed in each SCR drive.
- ◆ Lineator wide spectrum filters connected in series with vulnerable VFDs offer significant protection by isolating/attenuating the voltage spikes and other disturbances. Lineators also mitigate the VFD harmonics.
- ◆ If not practical to install AC line reactors then all critical loads should be protected by transient voltage surge suppressors.

8.0. Common mode voltage

Over the last 5-10 years the use VFDs have increased tremendously on offshore installations and drilling rigs. This popularity has resulted in a dramatic increase in a phenomena known as “common mode shift” (i.e. common mode voltage) which can have serious consequences.

Common mode shift originates at output of the VFD due to the non sinusoidal and high dv/dt (i.e. rate of rise of voltage) characteristic of the rapidly switched output voltages as illustrated in Fig 17.

Excessive common mode voltage can disrupt susceptible equipment resulting operational problems and is considered by many as the ‘IED’ of the offshore electrical world. Highly disruptive to susceptible equipment, it is rarely measured and can occur on almost any installation which has VFDs. The cause is often the incorrect installation of VFD equipment from an EMC (i.e. electromagnetic compatibility) perspective. Some examples of common mode interactions on drilling rigs are provided later in this paper.

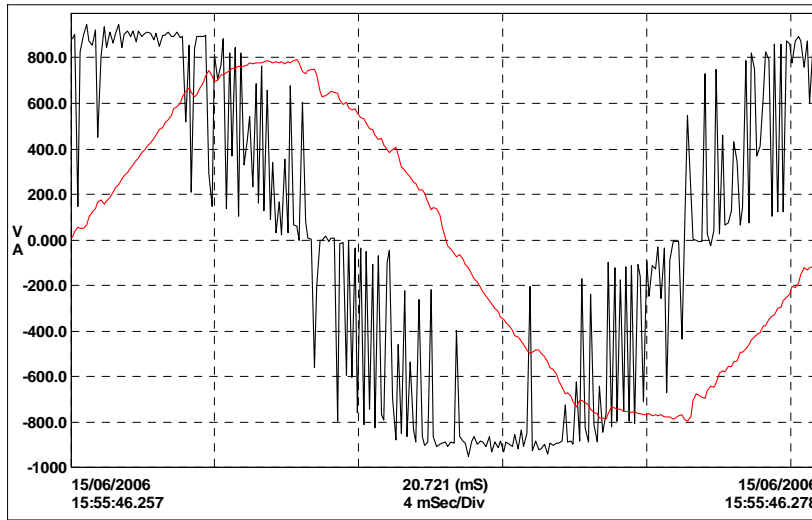

Fig 17 : Typical VFD output voltage (black) and current (red)

Common mode voltage (CMV) is an EMC (electromagnetic compatibility) issue. It can be measured between each phase and ground using an oscilloscope and spectrum analyser. An explanation of common mode voltage is complex and outwith the remit of this paper.

'EMC' covers electromagnetic phenomena over a very wide range of frequencies; the European EU Directive limits the frequency range from 0Hz (DC) to 400GHz.

VFDs are powerful emitters of electro-magnetic noise due to the rapid switching of output voltage and current. SCRs, benign by comparison, switch relatively slowly, limiting their emission spectrum to around 1MHz. VFDs which use IGBTs emit frequencies up to around 50MHz with most problematic emissions in the range 1-10MHz.

In the European Union there is a legal requirement to use specially designed EMC filters designed for 150kHz- 30MHz. Variable speed drives must also be installed in strict compliance with the drive manufacturer's EMC instructions (e.g. type of cable, cable routing, enclosure design and layout, grounding and bonding, etc.) to minimise emissions of EMI. Common mode EMI problems due to VFDs occur below 150kHz (i.e. usually 1-15kHz) and may require special filters and techniques.

The majority of offshore power installations are IT networks (i.e. isolated neutrals). These networks cannot use standard EMC filters since the filter capacitors have to be connected to ground and are destroyed should a ground fault appear on the system.

'Floating' EMC filters may be used with caution but this often raises causes safety concerns and successful implementation requires considerable EMC expertise and experience. Isolation transformers with electrostatic shielding can be very effective but also large and expensive. In some cases, capacitors to earth can be utilised to provide some, if inelegant, attenuation.

In addition to the conductive paths in the VFD (Fig 18), the common mode voltages and currents flow between the phases and ground through any stray capacitances [e.g. cables, motor/generator windings] to the grounded metalwork (i.e. the hull).

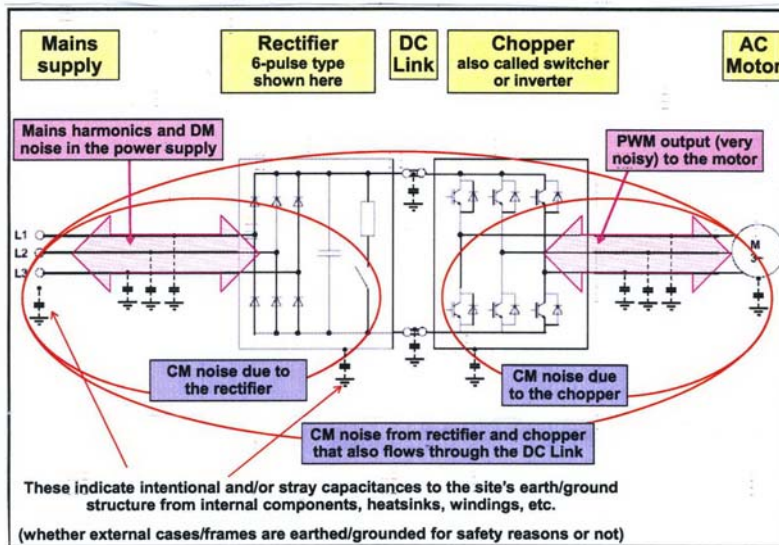

Fig 18 : Common mode voltage/current paths for VFDs on installations with IT networks (Cherry Clough)

The higher the frequency, the lower the impedance of the stray capacitances, which means that the VFD switching ‘noise’, consisting of very brief transient ‘spikes’ at the switching instants easily pass through the stray capacitances.

Common mode currents flow through cable insulation, through the air and through the metal structure of the hull and any item of electrical equipment connected to it. Installing EMC filters (i.e. ungrounded types) or isolating transformers at the VFD input essentially provides a shorter path for common mode currents so they flow through less items of equipment, thus sparing their control systems the EMI exposure and subsequent problems which may result.

Some examples of typical site common mode voltage problems follow :

Example One. This involved jack-up rig with a hybrid drilling package (i.e. SCRs for mud pumps and VFDs for draw-works and top drive). The red trace in Fig 19 represents the Phase V1 to ground voltage when no drilling package VFDs are assigned or running. All equipment on the MODU operated without any problems during this period.

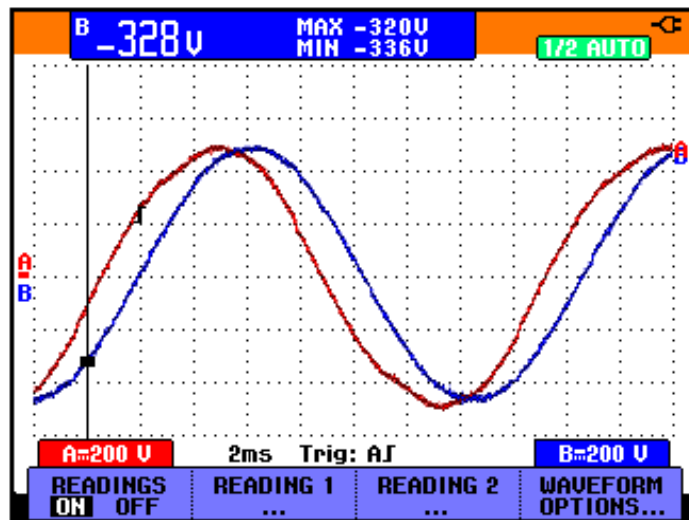

Fig 19 : Common mode voltage (red) with no drilling package VFDs running or assigned

In Fig 20 the red trace represents the Phase V1 to ground voltage when either of the drilling package VFDs were assigned or running. The consequences of the voltage rendered all three deck cranes ‘dangerous’ as the common mode voltage interfered with the crane electronic control systems. The rig was taken off contract until the crane problems could be resolved.

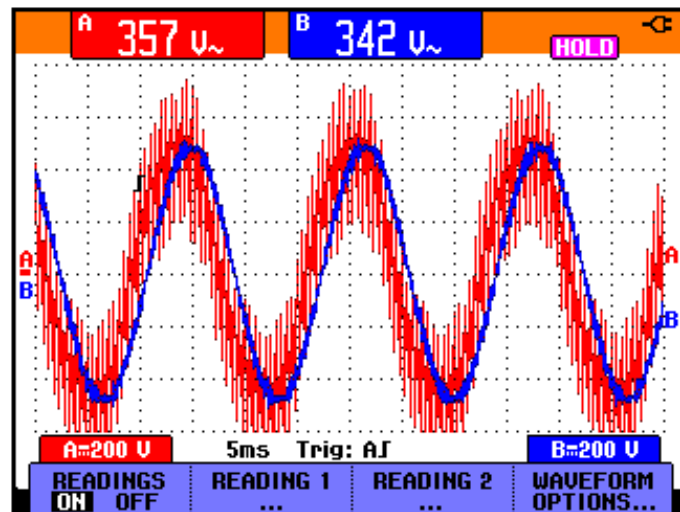

Fig 20 : Red trace is common mode voltage when the drilling package VFDs running

The common mode voltage (Fig 21) can be seen at 153V at 1.98kHz (i.e. switching frequency of the VFDs); the highest recorded voltage was 203.54V.

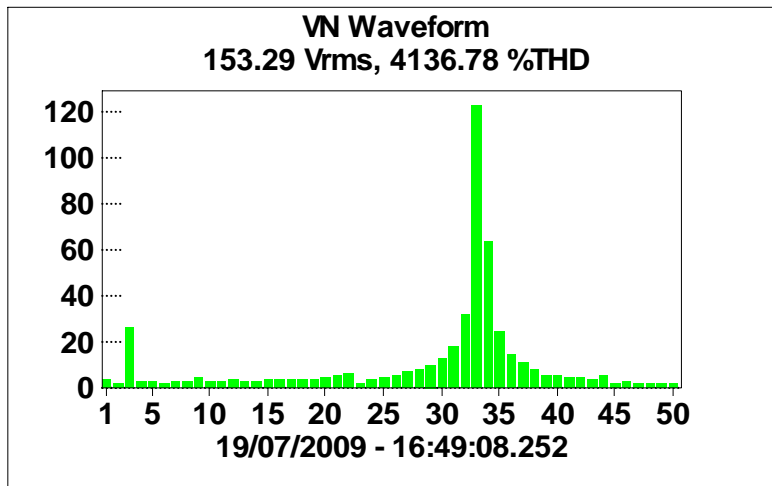

Fig 21 : Harmonic voltage spectrum of common mode voltage when the were VFDs assigned or running

Note that the 3rd harmonic voltage in the Fig 21 voltage spectrum is due to the dissimilar pitch phenomena which occurs when generators are paralleled.

Example Two. This example illustrates the effects of common mode voltage on the operation of a jack-up fire and gas detection system. The left trace (Fig 22) illustrates the control pulses when the system operated normally. The right trace illustrates the result when a new 1200HP/900kW VFD was connected to the system.

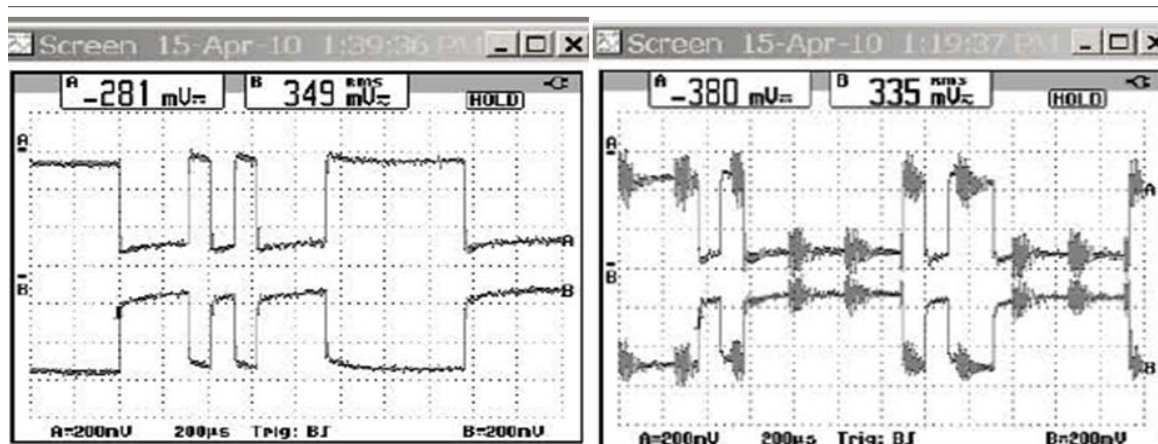

Fig 22 : Fire and Gas Detection System. Left trace is normal control pulse train. Right trace is with a 1200HP/900kW VFD running.

When the cement pump was operating (lower trace, Fig 22) the fire and gas detection system faulted continuously, resulting in spurious gas alarms and was disabled until the cause of the failures were established and the system made fully operational again. This left the rig and the personnel at risk for some days.

Example Three. The path for common mode voltage (Fig 23) and current is from the VFD IGBT output bridge, along the cables to the motor, across the air gap to the rotor and also via the bearings to ground (i.e. the hull).

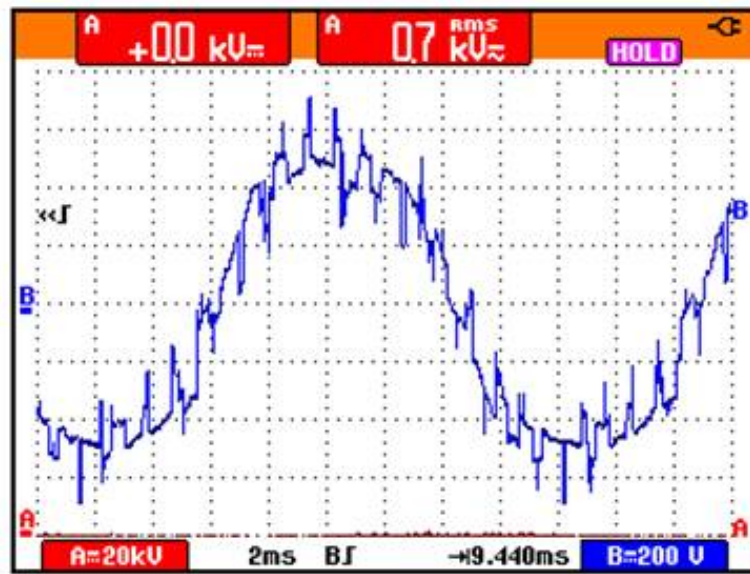

Fig 23 : Typical common mode voltage waveform (1.26kHz VFD switching frequency)

Fig 24 illustrates the affect of excessive common mode voltage through electrostatic discharges (ESD) on a 2500kW shaft generator with VFD voltage controller. The cause of the damage to the flexible coupling and bearings was incorrect EMC installation procedures (e.g. no special VFD rated cables from the VFD to the switchboard, incorrect glanding of cable shields and excessively long ground pigtails).

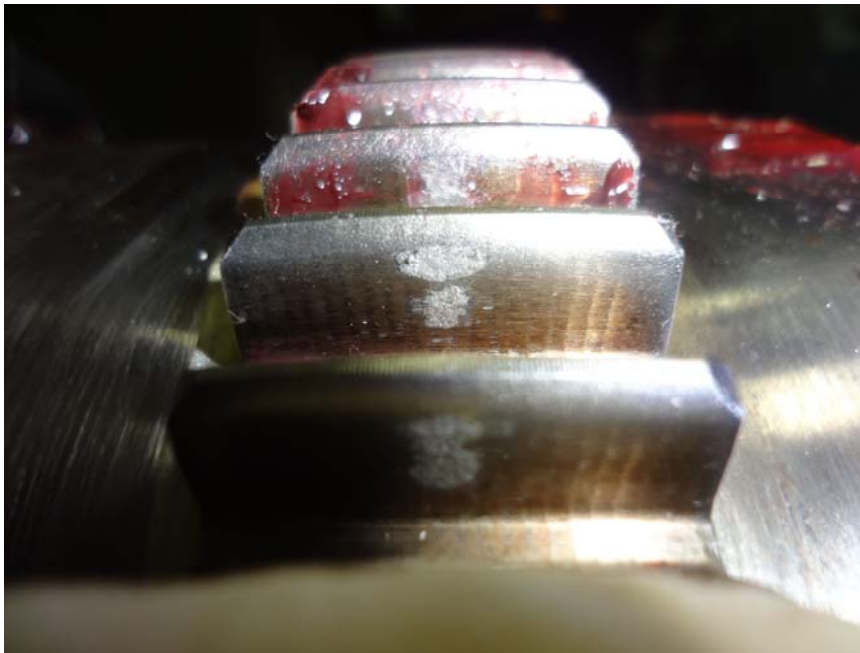

Fig 24 : Pitting on the flexible coupling of a 2500kW shaft generator due to common mode voltage

Fig 25 illustrates the voltage measured across the shaft of the generator.

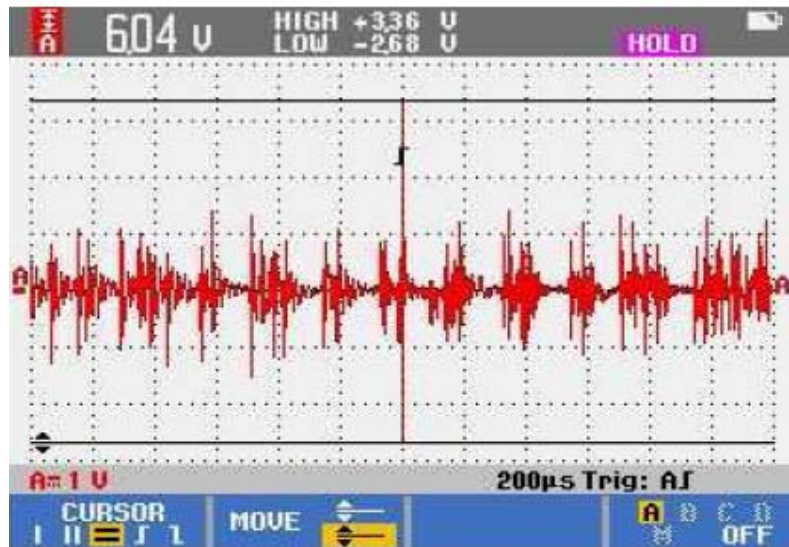

Fig 25 : Common mode derived shaft voltage on the generator

Note that excessive common mode voltage/current and electrostatic discharges presents serious issues for all explosion-proof motors.

8.0.1. Mitigation of common mode voltage

- a) Excessive common mode voltage offshore is associated with the incorrect installation (from an EMC prespective) of VFDs and other power semi-conductor loads. Any resolution of CMV problems can be technically challenging, expensive and often involves modifications to the VFD wiring. The best solution is to emsure all VFDs be installed in strict compliance with the appropriate EMC recommendations. This includes special VFD rated motor cable, 360 degree screen/shield glanding, equipotential grounding and other measures.
- b) Critical equipment, susceptible to common mode voltage, can be isolated using double wound transformers with electrostatic shielding.

9.0. Low generator displacement power factor

VFDs have a high 'displacement power factor' (DPF), around 0.96-0.97 lag, irrespective of load. The 'true power factor' (TPF), which includes the 'harmonic distortion factor' always is lower and dependent on the harmonic current magnitude, which varies with load.

For SCR drives, both power factors are similar (and will be referred for simplicity as 'power factor' in this paper) and dependent on the SCR drive output DC voltage (DC motor speed) and torque demand (DC current). At SCR low speed/high torque operation the generators supply large amounts of reactive power (kVAr) to the drives reducing their power factor significantly, often to <0.3-0.4 lag, limiting their capability to supply the design kW without overheating.

Fig 26 below illustrates the rms current, power factor and reactive power demand (kVAr) for the SCR draw-works on a land-rig. As can be seen, the power factor reduces (and kVAr demand increases) during periods of increased current demand. The power factor and reactive power demand are dynamic and also dependent on the number of generators operating in parallel.

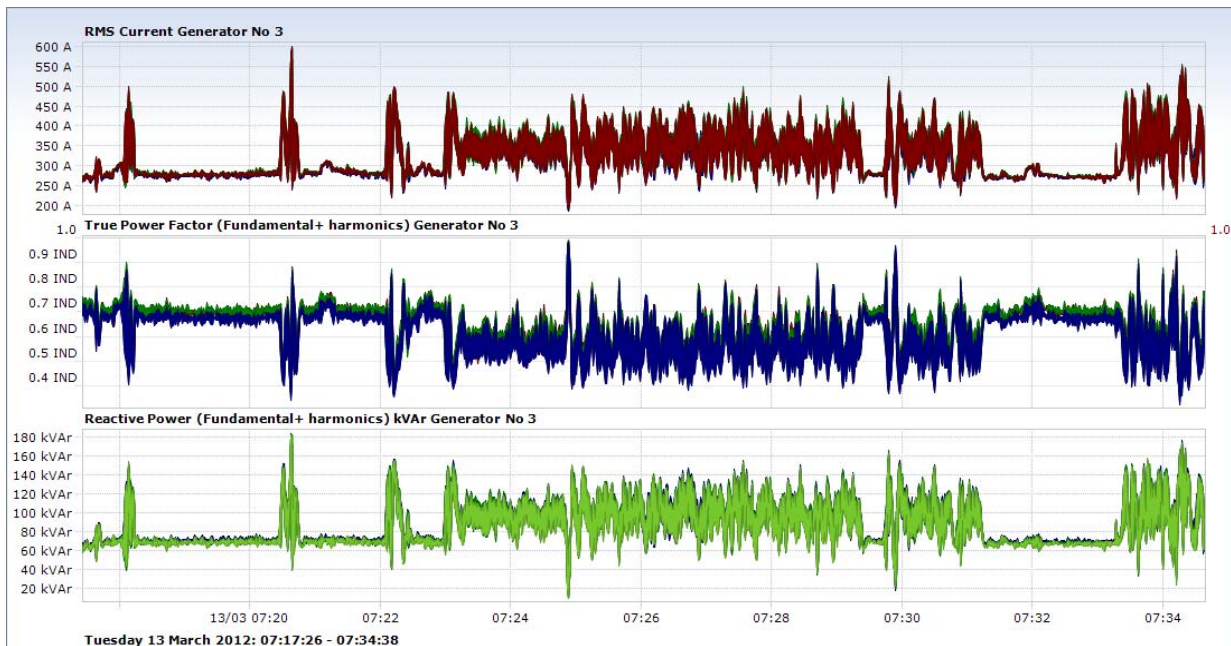

Fig 26 : Generator RMS currents, power factor and reactive power (kVAr) demand during light drilling load

As can be seen from Fig 26, the generator power factor reduced to a low of 0.32 lag during operations. Low power factor is inefficient and increases diesel fuel consumption. Fig 27 below shows a period of operation for the SCR draw-works and the relationship between the rms current, power factor and reactive power demand. Power factor, as low as 0.1 lag on occasion, can be observed.

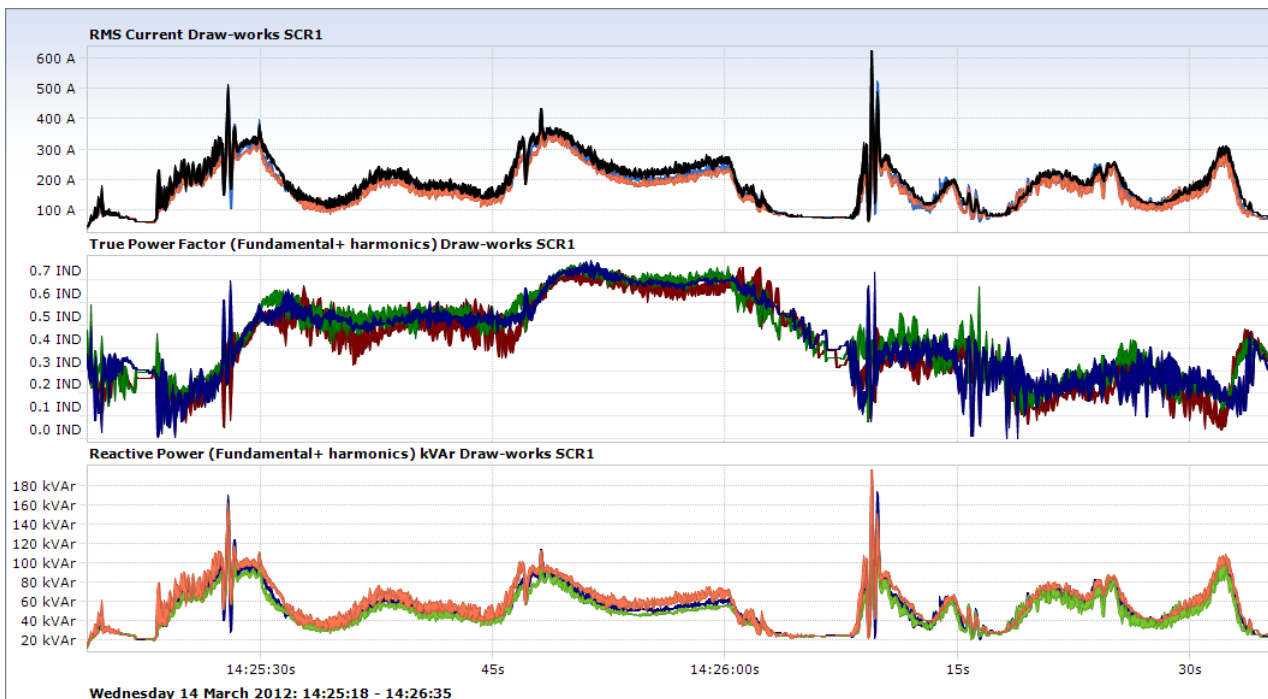

Fig 27 : Example of the relationship between rms current, power factor and reactive power (kVAr) on SCR draw-works

8.0.1. Mitigation for low generator power factor

- a) Conventional forms of power factor correction using capacitors switched by contactors are unsuitable for generator power systems as they cannot respond fast enough to satisfy the instantaneous kVAr demands from SCR drives and can lead to generator instability.
- b) Active filters can be used for power factor control and harmonic mitigation. All SCR drives require at least 3% AC line reactors; this is fundamental to success of the installation. Active filters used without line reactors in each SCR drive are susceptible to damage from the SCR high frequency line notch energy. If the frequency of the notch energy coincides with the active filter’s carrier frequency the carrier filter will be destroyed and the active filter rendered inoperable.

- d) An option for rigs with SCR drilling packages which does not require AC line reactors is a cycle by cycle SCR based reactive power control systems. When combined with a suitable detuned capacitor bank these systems can offer an excellent level of power factor control (which will not go leading) and a more than reasonable degree of harmonic voltage mitigation.

Note that all VFDs, including top drives have a displacement power factor (~ 0.96 lag), irrespective of load with low fundamental kVAr demands.

10.0. Rationale for measurements

Regular power quality measurements, including common mode voltage, are essential and should be carried out by experienced power quality (PQ) engineers to ensure that operational integrity and the safety of rig and its personnel is not compromised. This is especially valid if additional non linear equipment has been installed.

If no PQ measurements have been undertaken for some time then a full PQ audit should be carried out. Any mitigation contained in the report should be discussed fully between the PQ engineer and the operator or owner. The optimum solution must be practical from a performance, cost, maintainability and installation perspective for the specific installation. Space considerations, restrictions and any modifications required to install the mitigation equipment must be an integral part of the discussions.

11.0. Remote/local power quality monitoring

Affordable, low cost remote/local power and power quality monitoring systems are now available for the drilling and offshore industries (Fig 28).



Fig 28 : Power quality monitor installed in switchboard

This type of monitor permits local monitoring and display of all power and power quality parameters including real time waveforms, harmonic spectrums and trends. It also captures events and transients. The unit illustrated in Fig 28 will record and store trends and other data for up to one year (i.e. Blackbox function). Such a system can also be effectively utilised for power and harmonic analysis by rig electricians. One IP addressable PQ monitor can be installed on each generator or alternatively, a common PQ monitor can be utilised. The information is relayed to a dedicated laptop/computer or industrial HMI.

With a suitable internet connection the power and PQ data can be accessed remotely (e.g. to a technical office onshore) permitting individual rigs, rig fleets or complete oilfields to be monitored from anywhere in the world.

Examples of information from the PQ monitor follow :

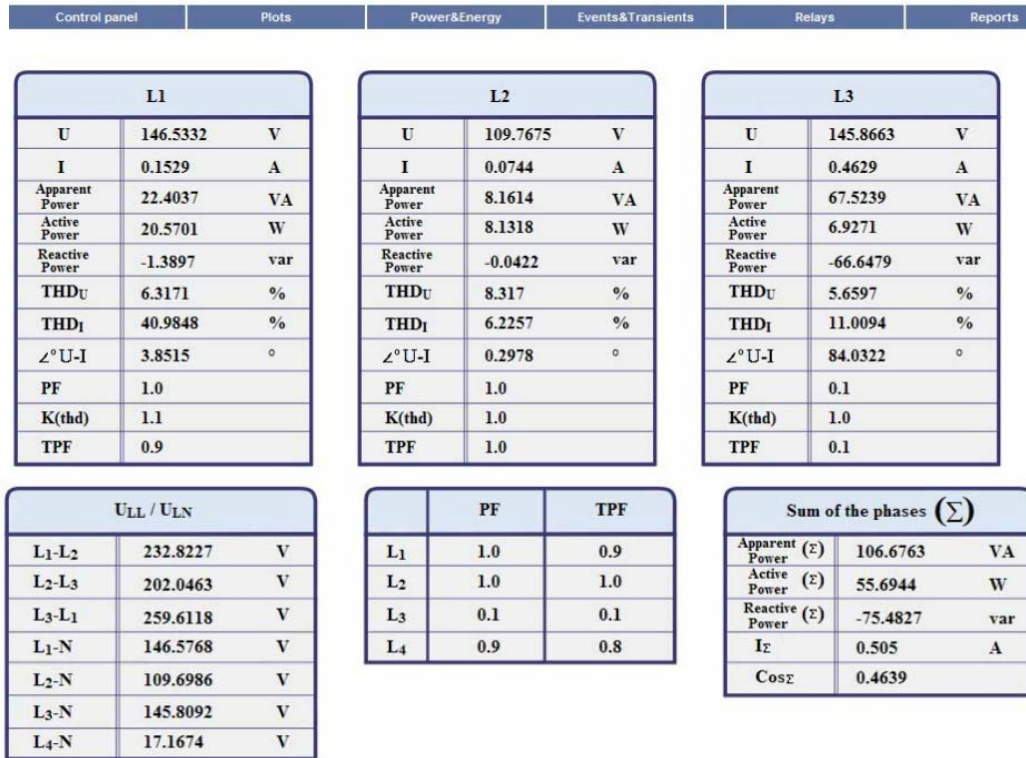

Fig 29 : Example of a PQ monitoring unit salient power and PQ parameter information page

Fig 29 illustrates the summary dashboard of a PQ monitoring system. The tabs represent various sections of the measurement menu, each has several sub-sections.

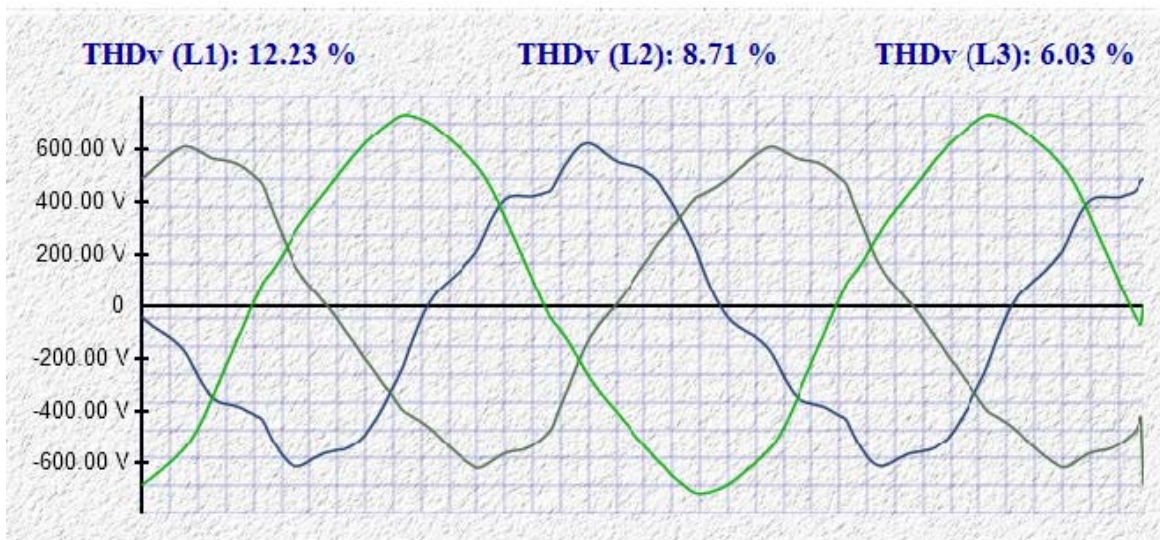

Fig 30 : Sample of real time line voltage waveforms and Uthd from PQ monitoring system

Fig 30 is an illustration of real time line voltage waveforms. The waveforms to be displayed are selected by ticking the appropriate boxes at the bottom of the screen (not shown).

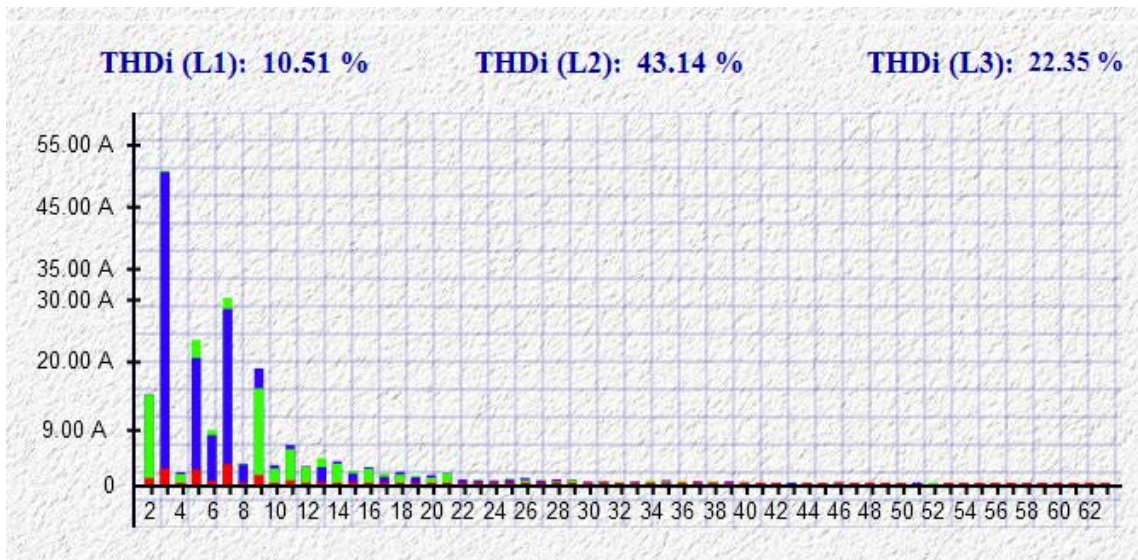

Fig 31 : Sample of harmonic voltage spectrum (to the 63rd order)

Fig 31 illustrates the real time harmonic current spectrums with the fundamental current removed to provide enhanced detail.

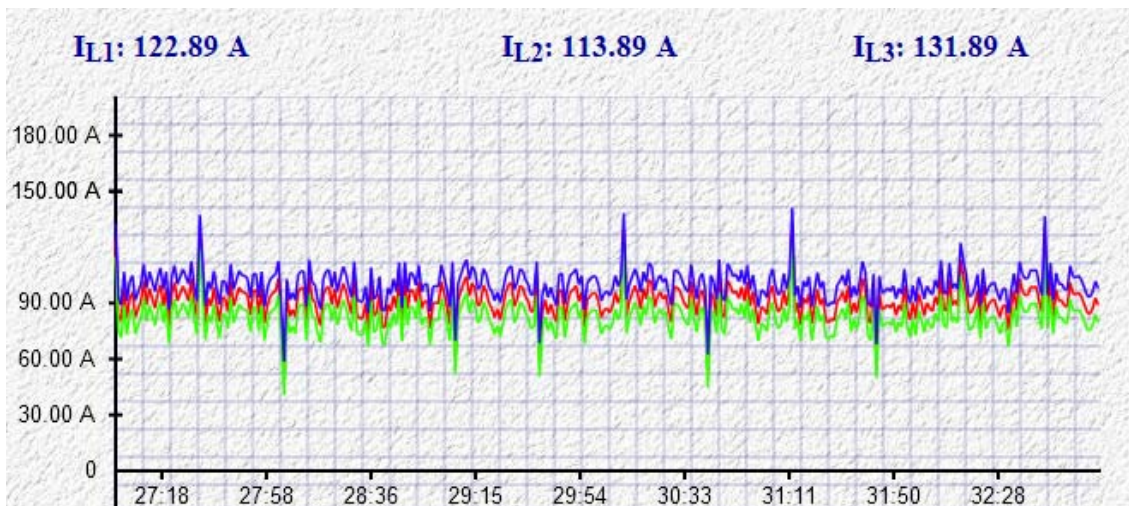

Fig 32 : Real time rms current trend

Fig 32 is an example of a real time trend, in this case, rms phase currents. The trend lines can be expanded and interrogated to assist in analysis. Trend information is fully flexible and readily available in real time and historically to provide full coverage for all power and power quality parameters.

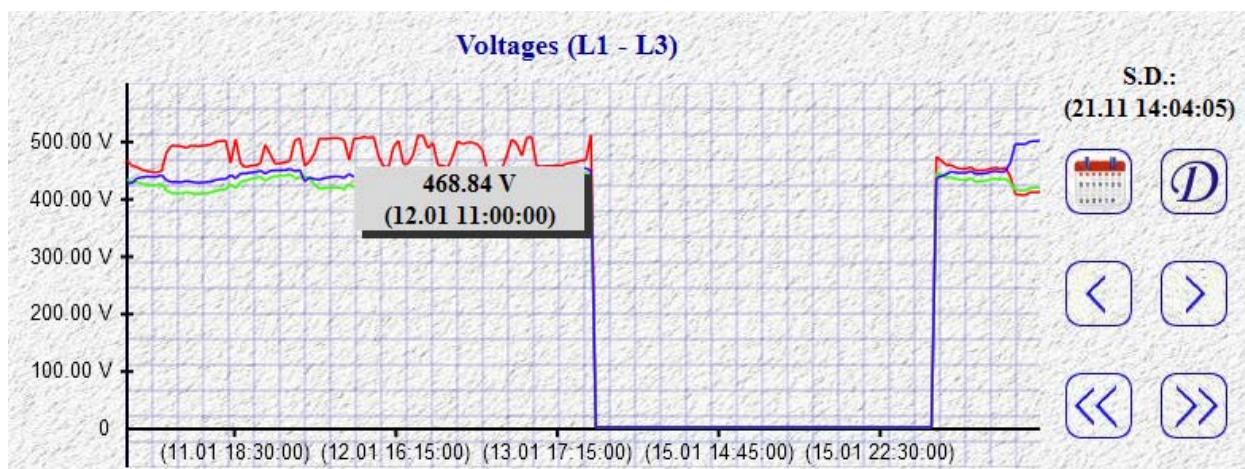

Fig 33 : Viewing historical data on PQ monitoring device

Fig 33 illustrates a historical trend for line voltage. The device can store up to 12 months worth of continuous recordings which are accessed via the calendar icon on the right hand side of the display. By using the calendar and tab buttons exact times for the information requested can be selected. All historical data can be accessed similarly. Any trend line, transient or event detail can be expanded for analysis.

Summary and conclusions

This paper has hopefully conveyed to the reader both the importance of electrical power quality and also provided a basic insight into the salient power quality problems encountered on drilling rigs and platforms.

In the future, offshore power quality will be under increased scrutiny by safety authorities worldwide. Marine classification bodies will be forced to adopt a more rigid approach to harmonics and EMC, including formal compliance testing on new builds. New rules may have to be introduced.

Harmonics and other aspects of poor power quality impact on operations and indeed, on profitability. In some cases poor power quality can result in the safety of the installation and personnel being compromised. Any downtime is extremely expensive. The cost of mitigation required to ensure prevention of that downtime is but a tiny fraction of the losses incurred.

Experienced offshore PQ engineers, proven mitigation products and affordable remote/local PQ monitoring systems are all readily available to assist owners and operators ensure their power quality is at an acceptable level.

The quality of electrical power is so crucial to the industry, including in regard to future subsea installations, that it cannot be ignored or swept under the carpet.

Offshore electronic equipment is getting more sophisticated and demands a higher level of power quality for its reliable operation than is the case to date.

In summary, an acceptable level of power quality is absolutely fundamental for the drilling and oil industries worldwide now, and increasingly so into the future. It is hoped that the information provided in this paper will assist in reinforcing that message.

Nomenclature

SCR = silicon controlled rectifier

VFD = variable frequency drive

PQ = power quality

AC = alternating current

DC = direct current

ABS = American Bureau of Shipping

MODU = mobile offshore drilling unit

HSE = Health & Safety Executive (UK)

IGBT = insulated gate bipolar transistor

kW = kilowatt

CMV = common mode voltage

kVAr = reactive kilo voltage amps

EMI = Electromagnetic interference

IEC = International Electrotechnical Commission

U_{thd} = line total harmonic voltage distortion

V_{thd} = phase total harmonic voltage distortion

I_{thd} = total harmonic current distortion

DPF = displacement power factor

TPF = true power factor

EMC = electromagnetic compatibility

References

1. Bourguet S., Guerin P, Le Doeuff R., *Non-characteristic harmonics generated by frequency converter*, GE44 , Laboratory, Saint-Nazaire, France, All Electric Ship 2003, Edinburgh.
2. *Guidance Notes on Control of Harmonics in Electrical Power Systems*, Pub 150. May 2006, American Bureau of Shipping.
3. IEC 60034-1, *Rotating electrical machines – Part 1: Rating and performance*, 2004-04, International Electrotechnical Commission IEC 60034-12, *Rotating electrical machines – Part 12: Starting performance of single-speed three-phase cage induction motors*, 2002-04, International Electrotechnical Commission.
4. Evans I C., *Are We Playing with Fire*, Electrical Review (UK), Vol. 221. No 3. Feb 1988. Page 32.
5. *Offshore Standards, DNV-OS-D201 – Electrical Installations*, April 2011, Det Norske Veritas.
6. *Rules and Regulations for the Classification of Ships*, July 2001, Lloyds Register of Shipping.
7. Evans I C., Hoevenaars A H., *Meeting Harmonic Limits of Marine Vessels*, ESTS 2007, Arlington, VA, May 2007.
8. Evans I C, Richards M J., *“The Price of Poor Power Quality”*, AADE11, Houston, Texas, Feb 2012.
9. Evans I C., Johnson J., *Practical Aspects of Applying Broadband Active Filters on Four Applications*. EPQU 2007, Barcelona, Spain, October 2007.
10. Hoevenaars A H., Evans I C., Desai B., *Preventing AC Drive Failures due to Commutation Notches on a Drilling Rig*. PCIC-2009, September 2007.

